

Structural system XD

Contents

System information.....	439	Enclosure profiles.....	441	P0
Beams XD	440	Enclosure strips	442	CC
Support beams.....	440	Multiblock	442	X45
Cover strip.....	440	Door accessories.....	442	XS
Angle brackets.....	440	Components for XD doors in XD frames	442	X65
Connecting strips	440	Components for XD doors in XC frames	442	X65P
T-slot nut.....	441			X85
Adjustable feet.....	441			X85P

System information

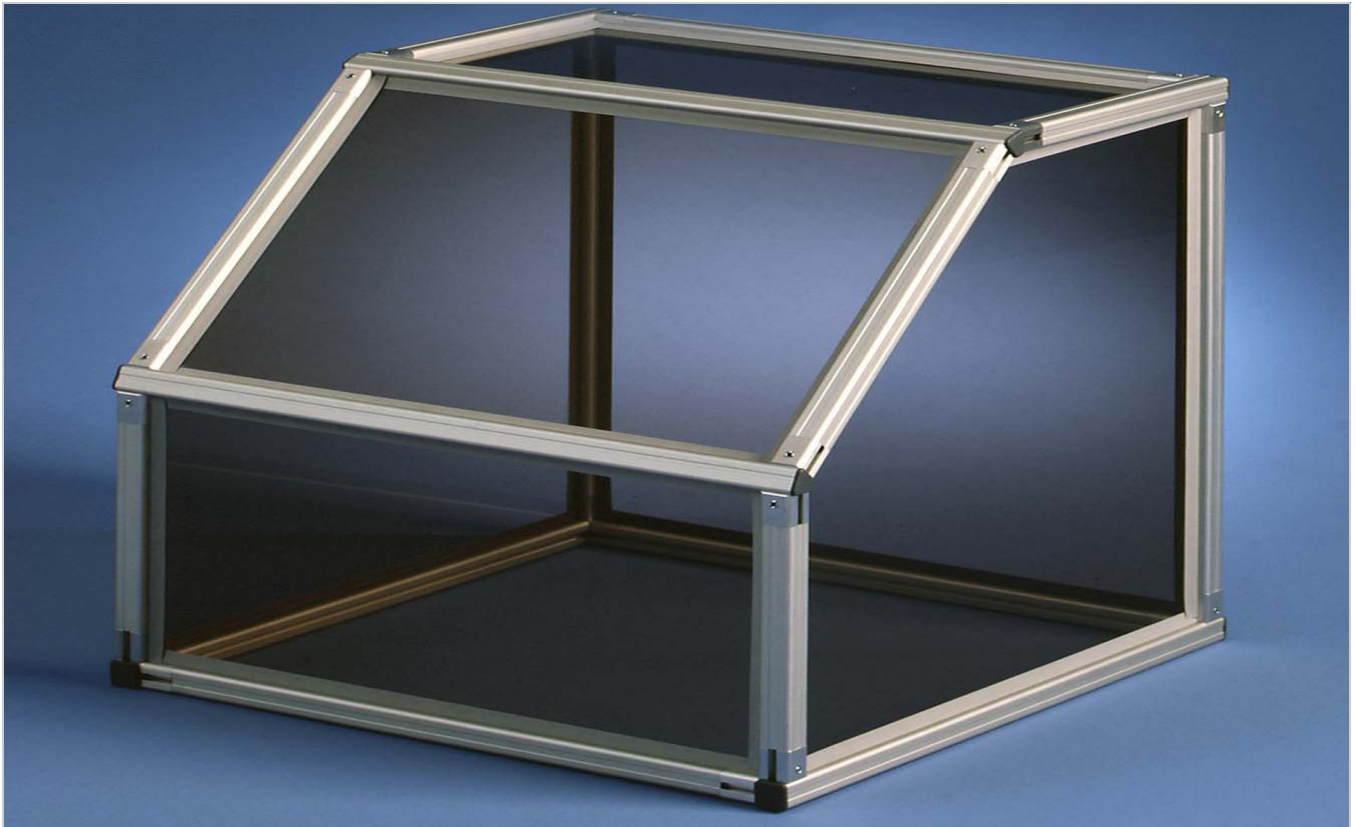

Features

Structural system XD is based on the module 22 mm (XC: 44 mm, XF: 30 mm). Attractive styling and re-usability makes XD equally suitable for prototypes and production quantities.

Designing and building a XD structure is simple and straightforward, and the resulting design retains the flexibility typical of all products from FlexLink Systems.

- P0
- CC
- X45
- XS
- X65
- X65P
- X85
- X85P
- XH
- XK
- XKP
- X180
- X300
- GR
- CS
- XT
- WL
- WK
- XC
- XF
- XD**
- ELV
- CTL
- FST
- TR
- APX
- IDX

Beams XD

Lengths and tolerance aluminium beams

"3 m" aluminium beams

If no other tolerance is stated in the catalogue all "3 m" aluminium beams will be delivered with a length of 3030 ±5 mm

The extra length compensates for cut losses on local site.

"L-cut" aluminium beams

If no other range is mentioned in the catalogue L-cut aluminium beams can be ordered in the range of 30-3000 mm.

Length tolerances:

Cut length L (mm)	Length tolerance (mm)
30-1000	±0,3
1001-2000	±0,5
2001-3000	±0,8

Support beams

Support beam 22×22

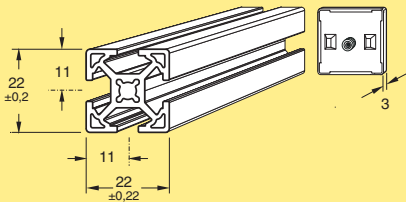

Beam 22 mm × 22 mm
Aluminium, anodized
Length 3 m (3030 ±5 mm) **XDBM 3x22**
Length to order (30- 3000 mm) **XDBM Lx22**
End cap, polyamide **XDBE 22 L**

Cover strip

Cover strip, PVC

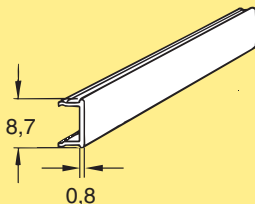

Cover strip
Length 3 m
Polyvinyl chloride **XDAC 3 P**

Angle brackets

Angle bracket, die-cast, 20×20×20



Angle bracket
Aluminium, die-cast **XDFA 22 A**
Mounting: MLC6S 5×8, BRB 5,3×10, XDAN 5 A

Connecting strips

Connecting strip

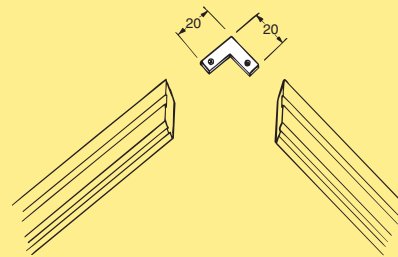

Angular connecting strip 90°
Including set screws
Steel, electro-zinc-plated **XDFW 9**

Connecting strip

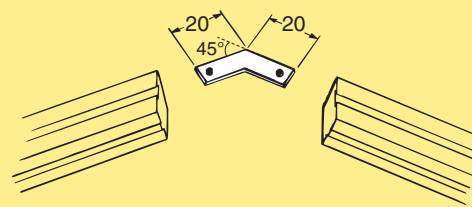

Angular connecting strip 45°
Including set screws
Steel, electro-zinc-plated **XDFW 9x45**

Connecting strip

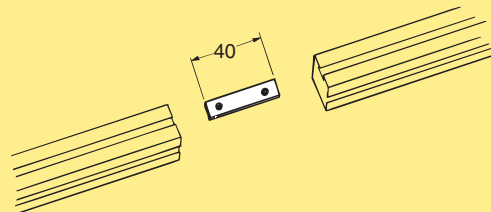

Connecting strip, straight
Including set screws
Steel, electro-zinc-plated **XDFC 9x40**

T-slot nut

T-slot nut for System XD T-slot

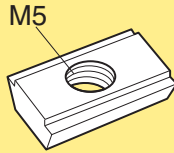
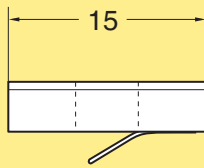

T-slot nut for XD
Steel, zinc-chromated
M5

XDAN 5 A

Adjustable feet

Adjustable foot

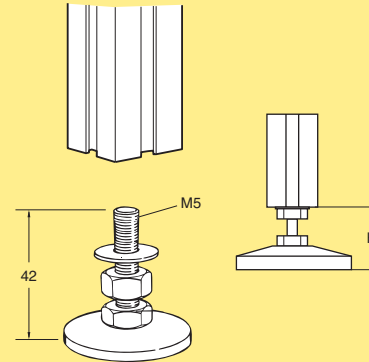

Adjustable foot (M5 screw)
H=21-30 mm
Steel, electro-zinc-plated
M5 thread

XDFS 5x30

Including nut. Maximum vertical load 250 N

Enclosure profiles

Enclosure beam 22x22, four T-slots

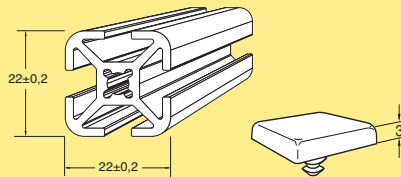

Enclosure profile, square section
22 mm x 22 mm, four T-slots
Aluminium, anodized
Length 3 m (3030 ±5 mm)
Length to order (30- 3000 mm)

XDEB 3x22
XDEB Lx22

End cap, polyamide, grey

XDEE 22*

With standard XD T-slots and hole for M5
*Note. Must be ordered in multiples of 10

Enclosure beam 22x22, two T-slots

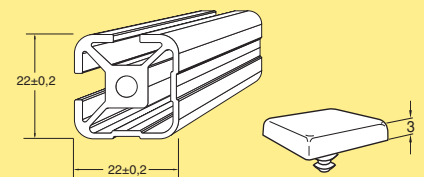

Enclosure profile, square section
22 mm x 22 mm, two T-slots
Aluminium, anodized
Length 3 m (3030 ±5 mm)
Length to order (30- 3000 mm)

XDEB 3x22 T2
XDEB Lx22 T2

End cap, polyamide, grey

XDEE 22*

With standard XD T-slots and hole for M5
*Note. Must be ordered in multiples of 10

Enclosure beam 22x22, three T-slots

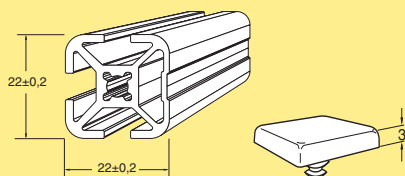

Enclosure profile, square section
22 mm x 22 mm, three T-slots
Aluminium, anodized
Length 3 m (3030 ±5 mm)
Length to order (30- 3000 mm)

XDEB 3x22 T3
XDEB Lx22 T3

End cap, polyamide, grey

XDEE 22*

With standard XD T-slots and hole for M5
*Note. Must be ordered in multiples of 10

Enclosure connector kit

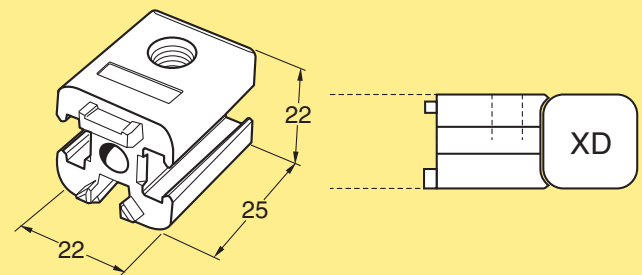

Enclosure connector kit
Aluminium, die-cast

XDEF 22

Including the necessary mounting hardware

Enclosure strips

Rim strip

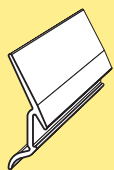

Rim strip
Length 3 m
Polyvinyl chloride, grey

XDET 3 A

Net strip

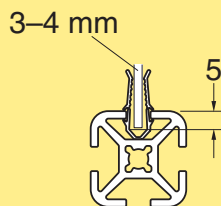
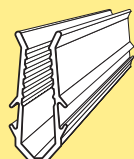

Net strip
Length 3 m
Polyvinyl chloride, grey

XDET 3 C

Multiblock

Multiblock

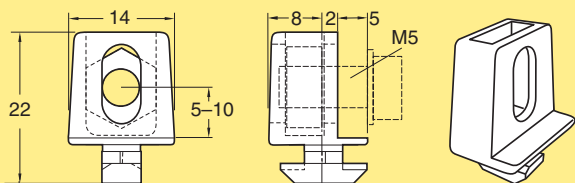

Multiblock
Polyamide
Including M5 square nut

XDAM 2

Door accessories

Handle assembly XC/XD/XF, polyamide

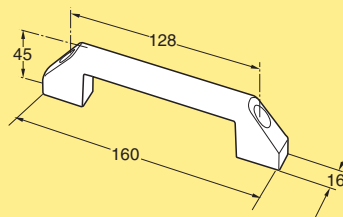

Handle assembly
Polyamide

XDEH 160

Including adapter plate for XC
Mounting XD: MC6S 5x12 (2), XDAN 5 A(2)

Components for XD doors in XD frames

Hinge kit XD-XD

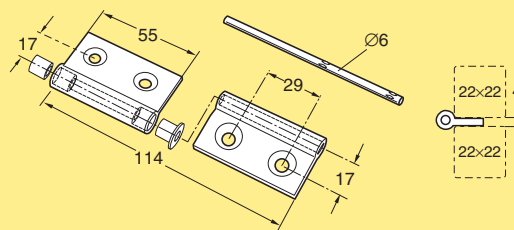

Hinge kit XD-XD
Aluminium

XDAH 110 B

Including the necessary mounting hardware

Components for XD doors in XC frames

Ball latch lock kit XD-XC

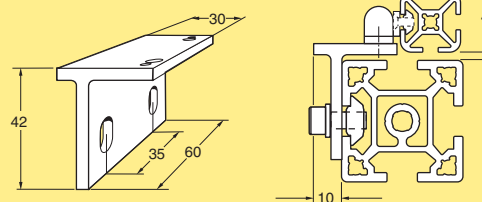

Ball latch lock kit
Aluminium, anodized

XDEL 60 BA

Including ball latch and the necessary mounting hardware